

DOWNLIGHT

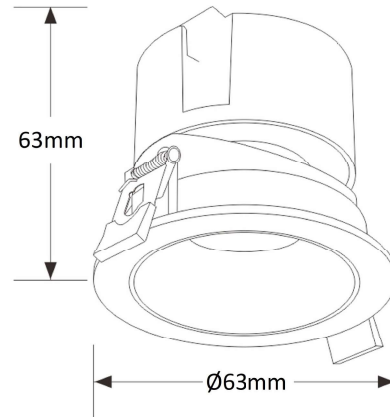

DESCRIPTION

USE HIGH PERFORMANCE COB LED, ALUMINUM HEATSINK AND UNIQUE DIE CASTING HEATSINK DESIGN ENSURE BETTER HEAT DISSIPATION.

FIXTURE DIM: Ø63mm x H63mm
 MATERIAL: DIE-CASTING ALUMINUM HEATSINK
 ACCESSORIES: REFLECTOR

LIGHT SOURCE AND PERFORMANCE

LIGHT SOURCE:	LED COB
SDCM:	-
CCT:	3000K
CRI:	≥90
SYSTEM POWER:	5W
DELIVERED LUMEN:	450lm
IP:	20

MOUNTING

RECESSED TRIM

OPTICS

BEAM ANGLE: 24°

ELECTRICAL / LED DRIVER

SUPPLY WITH NON-DIMMABLE DRIVER AC 100-240V

DIMMING OPTION

NO DIMMING

FINISH

WHITE

