

**DOWNLIGHT**

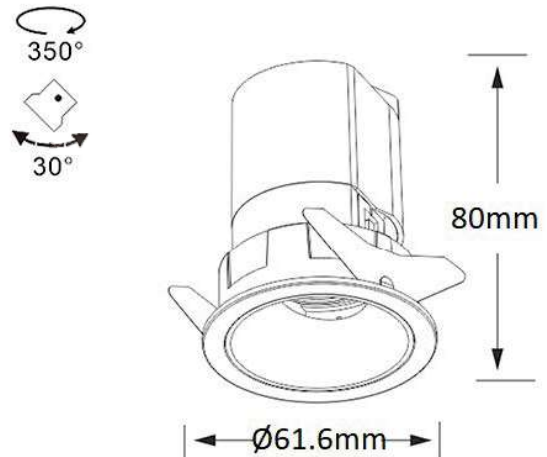

**DESCRIPTION**

USE HIGH PERFORMANCE LED, ALUMINUM HEATSINK AND UNIQUE DIE CASTING HEATSINK DESIGN ENSURE BETTER HEAT DISSIPATION.

FIXTURE DIM: Ø61.6mm x H80mm  
 MATERIAL: DIE-CASTING ALUMINUM HEATSINK

**LIGHT SOURCE AND PERFORMANCE**

LIGHT SOURCE:	LED
SDCM:	-
CCT:	5000K
CRI:	≥90
SYSTEM POWER:	7W
DELIVERED LUMEN:	630lm
IP:	20

**MOUNTING**

RECESSED TRIM

**OPTICS**

BEAM ANGLE: 15°

**ELECTRICAL / LED DRIVER**

SUPPLY WITH NON-DIMMABLE DRIVER AC 100-240V

**DIMMING OPTION**

NO DIMMING

**FINISH**

WHITE

