

DOWNLIGHT

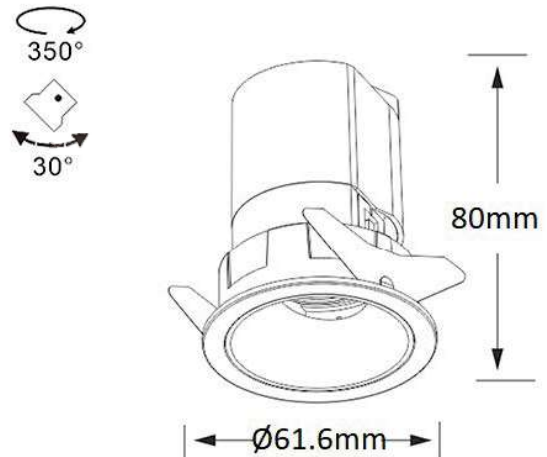

DESCRIPTION

USE HIGH PERFORMANCE LED, ALUMINUM HEATSINK AND UNIQUE DIE CASTING HEATSINK DESIGN ENSURE BETTER HEAT DISSIPATION.

FIXTURE DIM: Ø61.6mm x H80mm
 MATERIAL: DIE-CASTING ALUMINUM HEATSINK

LIGHT SOURCE AND PERFORMANCE

LIGHT SOURCE:	LED
SDCM:	-
CCT:	6000K
CRI:	≥90
SYSTEM POWER:	7W
DELIVERED LUMEN:	630lm
IP:	20

MOUNTING

RECESSED TRIM

OPTICS

BEAM ANGLE: 15°

ELECTRICAL / LED DRIVER

SUPPLY WITH NON-DIMMABLE DRIVER AC 100-240V

DIMMING OPTION

NO DIMMING

FINISH

WHITE

